

SPECIFICATIONS		
Rated Voltage	(VDC)	5.0
Operating Voltage	(VDC)	3~8
Rated Current	(mA)	MAX.30
Sound Output at 10cm	(dBA)	MIN. 85
Resonant Frequency	(Hz)	2400±500
Operating Temperature	(°C)	-25~+70
Storage Temperature	(°C)	-30~+80
Housing material		PPS
Weight	(g)	2.0

REVISION HISTORY			
LTR	DESCRIPTION	DATE	APPROVED

CHARACTERISTICS

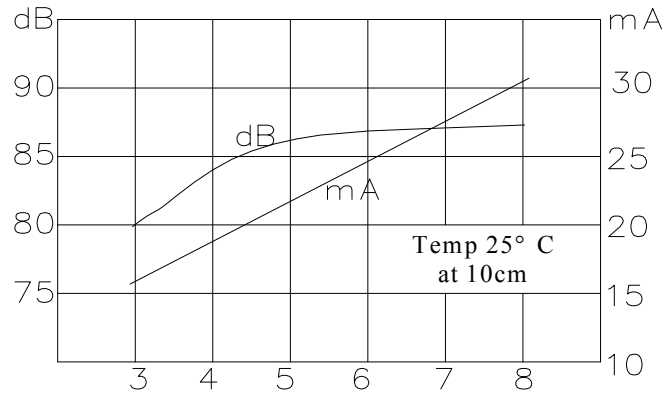

NOTES:

1. ALL DIMENSIONS ARE IN MILLIMETERS.
2. SPECIFICATIONS SUBJECT TO CHANGE OR WITHDRAWAL WITHOUT NOTICE.
3. THIS PART IS ROHS 2002/95/EC COMPLIANT.

DIMENSION:

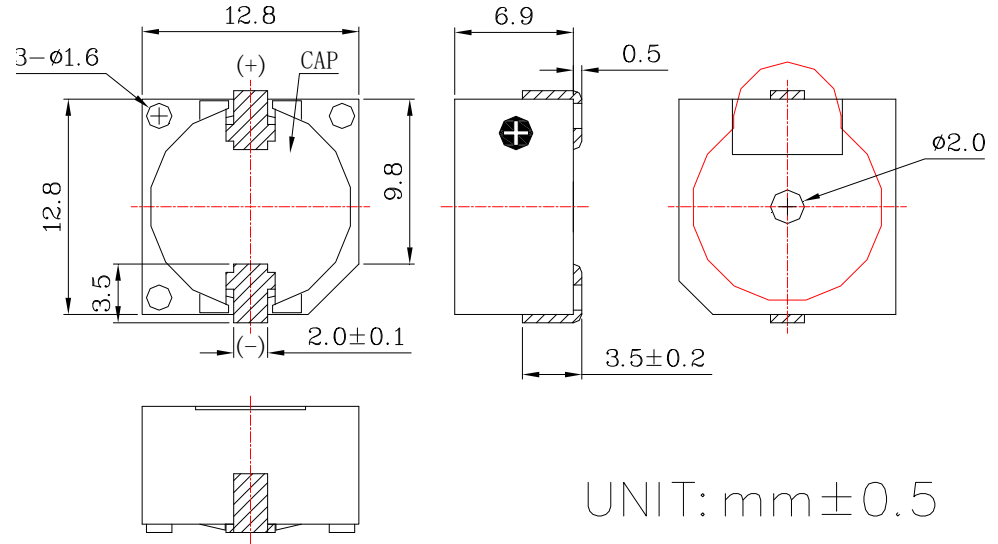

UNLESS OTHERWISE SPECIFIED	SIZE A4	Designed by	Date	Checked by	Date	Approved by	Date
DIMENSIONS ARE IN MILLIMETERS		Magnetic Transducer		MCW1313070-5V-2400-F			
TOLERANCES ARE ±0.5 AND ANGLES ARE ±3°				Changzhou Shenghui Electronic Co.,Ltd Tel:+86 519 85118108 Fax:+86 519 85108596 sales@shenghui.com http://www.shenghui.com			