

SPECIFICATIONS		
Rated Voltage	(Vo-p)	12.0
Operating Voltage	(Vo-p)	8~16
Rated Current	(mA)	MAX.40
Sound Output at 10cm	(dBA)	MIN.85
Coil Resistance	(Ω)	140±14
Resonant Frequency	(Hz)	2400
Operating Temperature	(°C)	-30~+70
Storage Temperature	(°C)	-40~+80
Housing material		PBT/NORLY
Weight	(g)	2.0

REVISION HISTORY			
LTR	DESCRIPTION	DATE	APPROVED

DIMENSION:

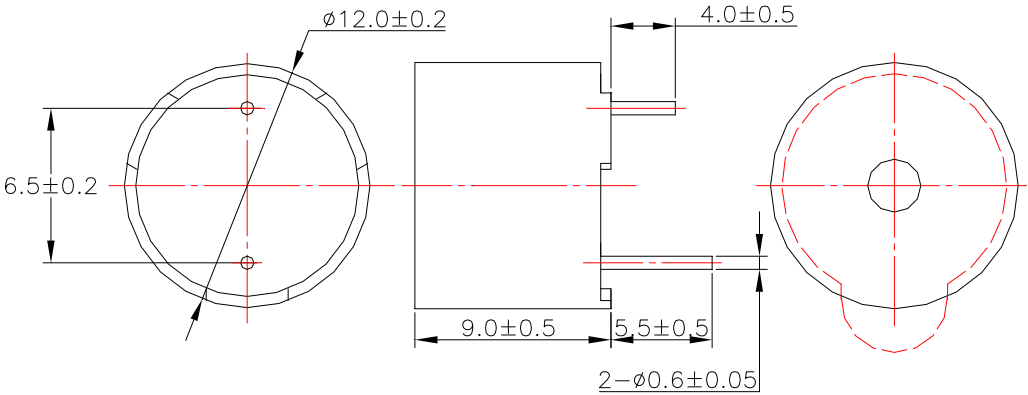

CHARACTERISTICS

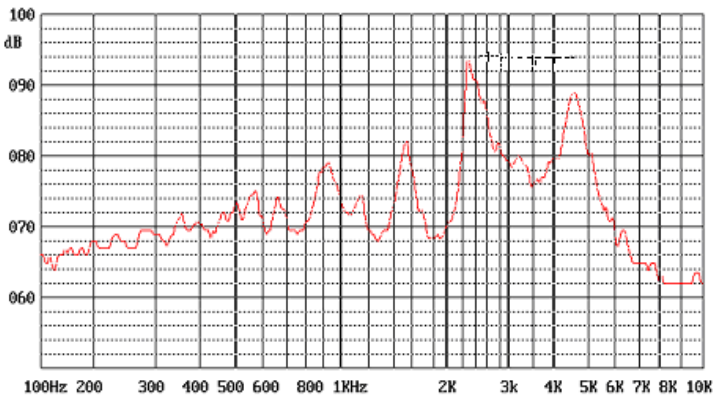

NOTES:

1. ALL DIMENSIONS ARE IN MILLIMETERS.
2. SPECIFICATIONS SUBJECT TO CHANGE OR WITHDRAWAL WITHOUT NOTICE.
3. THIS PART IS ROHS 2002/95/EC COMPLIANT.

UNLESS OTHERWISE SPECIFIED	SIZE	Designed by	Date	Checked by	Date	Approved by	Date
		Magnetic Transduce		MW12090-140R(12V)-2400-F			
DIMENSIONS ARE IN MILLIMETERS	A4			Changzhou Shenghui Electronic Co.,Ltd Tel:+86 519 85118108 Fax:+86 519 85108596 sales@shenghui.com http://www.shenghui.com			
TOLERANCES ARE ±0.5 AND ANGLES ARE ±3°							