

SPECIFICATIONS	
Dimension (mm)	Φ28.0×5.0H
Input Power (W)	0.5
Max Input Power (W)	1.0
Impedance (Ω)	8 ± 15% at 2kHz
Sensitivity (dB)	90 ± 3dB(0.1W,0.1M) average of 0.8,1.0,1.2,1.5 KHz
Resonance Frequency(Hz)	550±20%@1.0V Without Baffler
Frequency Range (Hz)	F0-20KHz
Operating Temperature (°C)	-20~+55
Weight (g)	8.0

REVISIONHISTORY			
LTR	DESCRIPTION	DATE	APPROVED

DIMENSION:

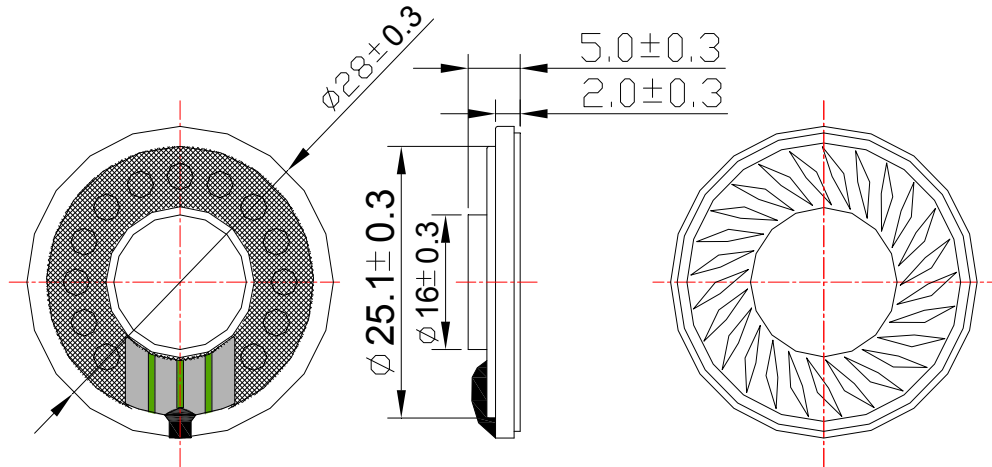

FREQUENCYRESPONSE:

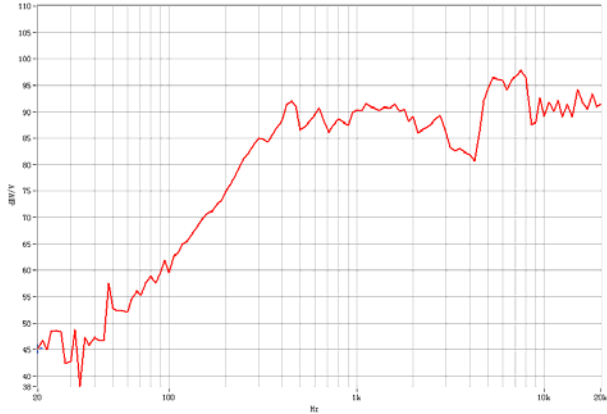

NOTES:

- 1.ALL DIMENSIONS ARE IN MILLIMETERS.
- 2.SPECIFICATIONS SUBJECT TO CHANGE OR WITHDRAWL WITHOUT NOTICE.
- 3.THIS PART IS ROHS 2002/95/EC COMPLIANT.

UNLESS OTHERWISE SPECIFIED	DESIGNED BY	DATE	CHECKED BY	DATE	APPROVED BY	DATE
DIMENSIONS ARE IN MILLIMETERS	SIZE A4	Mylar Speaker		SM28S502-8R-F		
TOLERANCES ARE ±0.5 AND ANGLES ARE ±3°				Changzhou Shenghui Electronic Co.,Ltd Tel:+86 519 85118108 Fax:+86 519 85108596 sales@shenghui.com http://www.shenghui.com		