

SPECIFICATIONS	
Dimension (mm)	22.0×9.0×3.6H
Input Power (W)	0.5
Max Input Power (W)	0.8
Impedance (Ω)	8 ± 15% at 2kHz
Sensitivity (dB)	86 ± 3dB(0.1W,0.1M) average of 0.8,1.0,1.2,1.5 KHz
Resonance Frequency(Hz)	1000±20%@1.0V Without Baffler
Frequency Range (Hz)	F0-20KHz
Operating Temperature (°C)	-20~+55
Weight (g)	1.8

REVISIONHISTORY			
LTR	DESCRIPTION	DATE	APPROVED

DIMENSION:

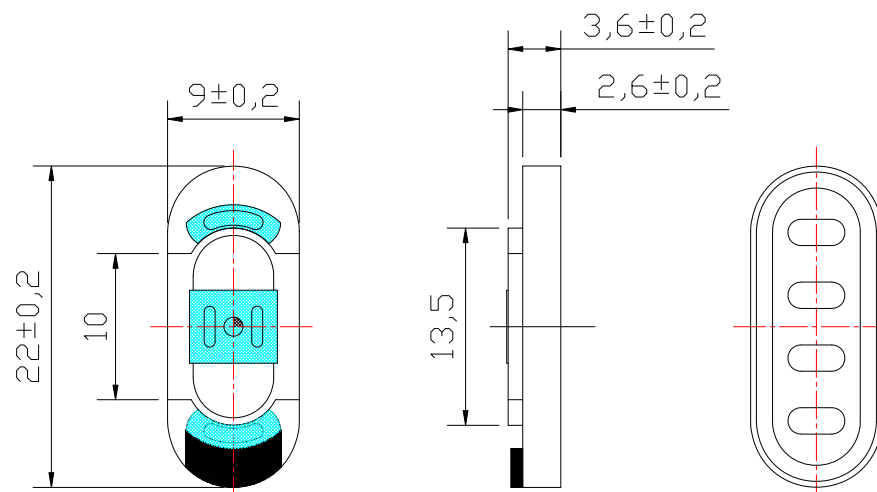

FREQENCYRESPONSE:

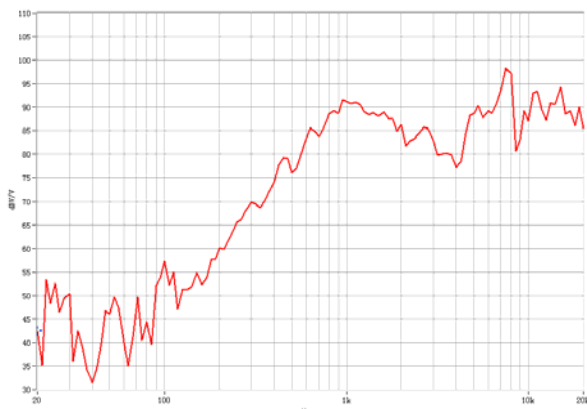

NOTES:

- 1.ALL DIMENSIONS ARE IN MILLIMETERS.
- 2.SPECIFICATIONS SUBJECT TO CHANGE OR WITHDRAWL WITHOUT NOTICE.
- 3.THIS PART IS ROHS 2002/95/EC COMPLIANT.

UNLESS OTHERWISE SPECIFIED	SIZE A4	Designed by	Date	Checked by	Date	Approved by	Date
DIMENSIONS ARE IN MILLIMETERS		Cell Phone Speaker		SM2209S200-F			
TOLERANCES ARE ±0.5 AND ANGLES ARE±3°				Changzhou Shenghui Electronic Co.,Ltd Tel:+86 519 85118108 Fax:+86 519 85108596 sales@shenghui.com http://www.shenghui.com			